

Thread and clamp couplings

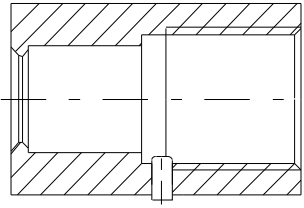

Standard coupling G1

Order codes:

- AISI316L M546197
- Duplex M5461978
- Hastelloy C276 M5461973
- Titaani M5461976

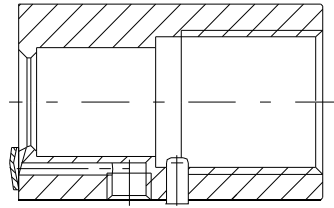

Standard coupling G1 with cleaning

Order codes:

- AISI316L M1050020
- Duplex M10500208
- Hastelloy C276 M10500203
- Titaani M10500206

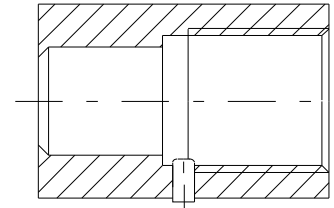

Hygienic coupling G1

Order codes:

- AISI316L M548101
- Duplex M5481018
- Hastelloy C276 M548102
- Titaani M548103

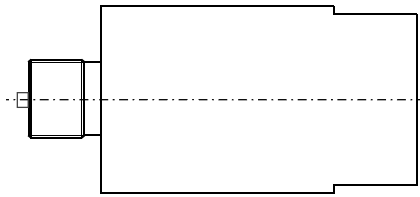

Coupling G1 / G $\frac{1}{2}$ A

Order code:

- AISI316L M546190

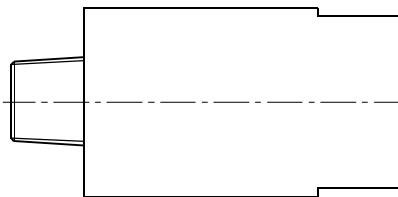

Coupling G1 / $\frac{1}{2}$ -NPT

Order code:

- AISI316L M551566

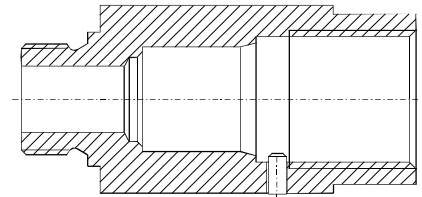

Coupling G1 / G $\frac{3}{4}$ A

Order code:

- AISI316L T1050218

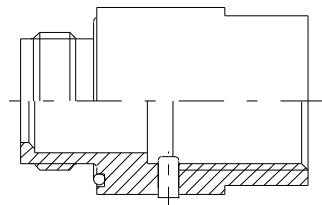

Coupling G1 / G1A

Order codes:

- AISI316L M1050002
- Hastelloy C276 M10500023

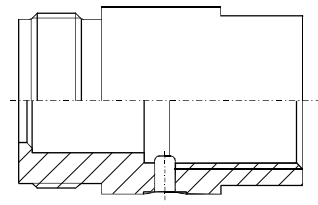

Coupling G1 / G1 $\frac{1}{4}$ A

Order code:

- AISI316L M1050014

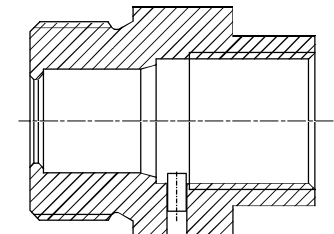

Coupling G1 / G1 $\frac{1}{2}$ A

Order code:

- AISI316L T1050214

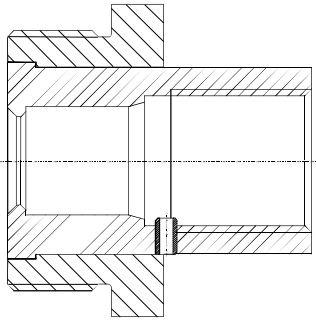

Coupling G1 / G2A

Order code:
- AISI316L M1050036

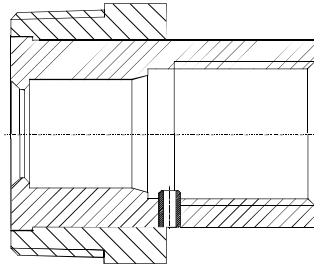

Coupling G1 / 2-NPT

Order code:
- AISI316L M1050028

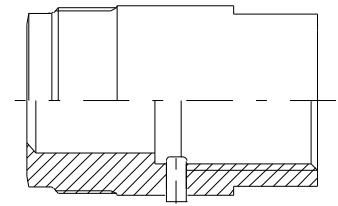

Coupling G1 / M44 x 1,25 (PMC)

Order codes:
- AISI316L M1050004
- Hastelloy C276 M10500043

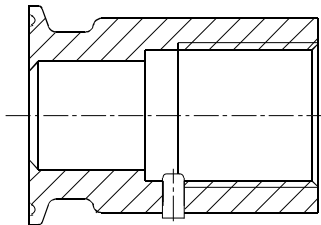

Coupling G1 / Hygienic coupling ISO2852 standard:

Order codes (AISI316L):
- Tri-Clamp 25/38 M1050206
- Tri-Clamp 40/51 M1050222
- Tri-Clamp 63,5 M1050224
- Tri-Clamp 70 M1050225
- Tri-Clamp 76,1 M1050226
- Tri-Clamp 88,9 M1050227
- Tri-Clamp 101,6 M1050228
- Tri-Clamp 114,3 M1050229
- Tri-Clamp 139,7 M1050230

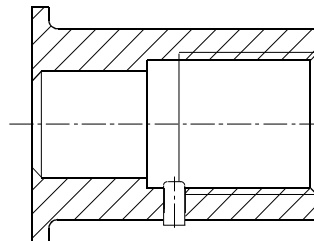

Coupling G1 / Hygienic coupling SMS standard:

Order codes (AISI316L):
- SMS 38 M1050265
- SMS 51 M1050267

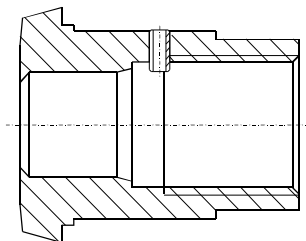

Coupling G1 / Hygienic coupling DIN11851/11887 standards:

Order codes (AISI316L):
- DN40 M1050312
- DN50 M1050313
- DN65 M1050314

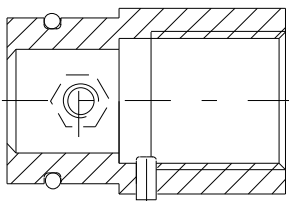

Coupling G1 / PMC 1,5"

Order codes:
- AISI316L M1050010
- Hastelloy C276 M10500103

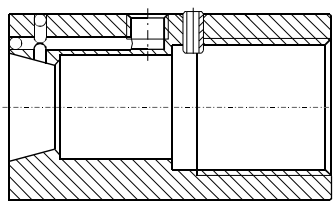

Extended coupling G1 with cleaning

Order code:
- AISI316L M1050293

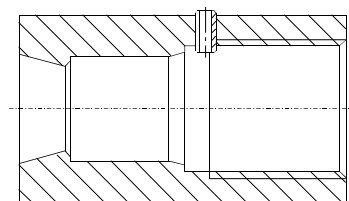

Extended coupling G1

Order codes:
- AISI316L M1050292
- Hastelloy C276 M10502923

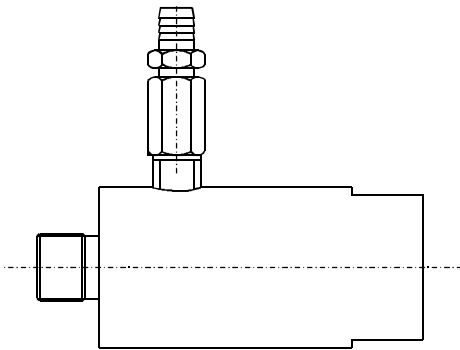

Coupling G1 / G $\frac{1}{2}$ A + drain valve

Order code:
- AISI316L M860280

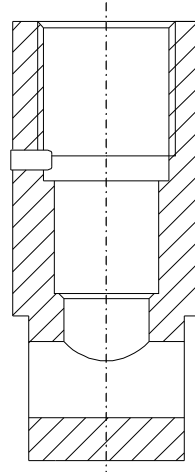

Coupling G1 for pipes
DN15 - DN25 and clean
liquids

Order codes (AISI316L):
- DN15 M1050295
- DN20 M1050296
- DN25 M1050297

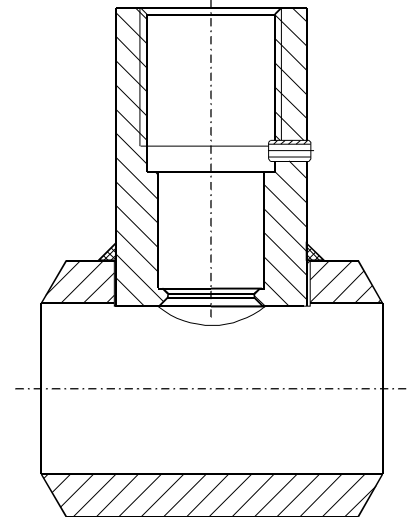

Coupling G1 for pipes
DN15 - DN40

Order codes (AISI316L):
- DN15 M105001615
- DN20 M105001620
- DN25 M105001625
- DN32 M105001632
- DN40 M105001640

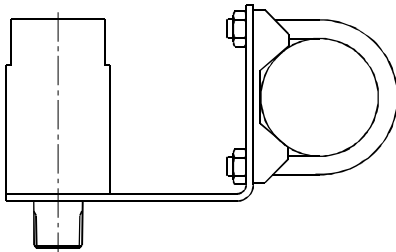

Coupling G1 / G $\frac{1}{2}$ A (male)
with mounting bracket

Order code:
- AISI316L M546195

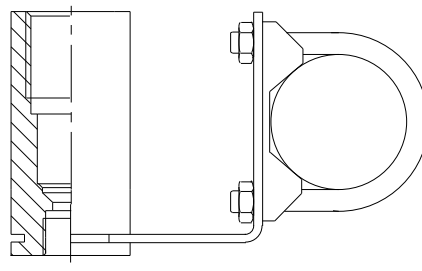

Coupling G1 / G $\frac{1}{2}$ (female)
with mounting bracket

Order code:
- AISI316L M550393

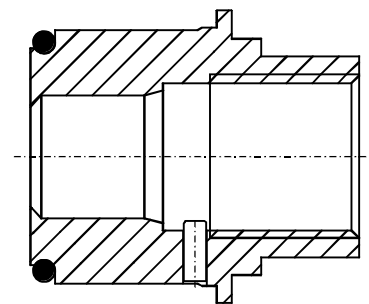

Coupling G1 / Ø52,5 L=38
(SMS nut fixing, size 38,
thread 60 x 1/6)

Order code:
- AISI316L M1050575

Coupling G1 / $\frac{1}{2}$ - NPT
(male) with mounting bracket

Order code:
- AISI316L M1050017

Coupling G1 / $\frac{1}{2}$ - NPT
(female) with mounting
bracket

Order code:
- AISI316L M550393N

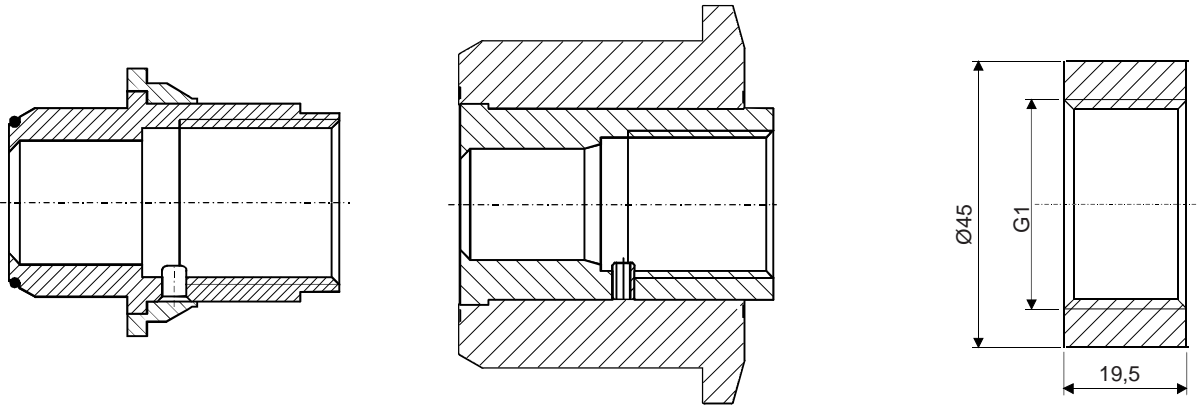

Coupling G1 / SMS-SI
- with extension

Order codes (AISI316L):
- SMS-SI38 M1050012
- SMS-SI51 M1050126

Coupling G1 / Sandvik-clamp
- Extension length 54,5 mm

Order codes:
- AISI316L M1050037
- Duplex M10500378
- Hastelloy C276 M10500373

Thread sleeve G1
(eg. for coupling M1050002)

Order codes:
- AISI316L M1050220
- Hastelloy C276 M10502203

Flange couplings

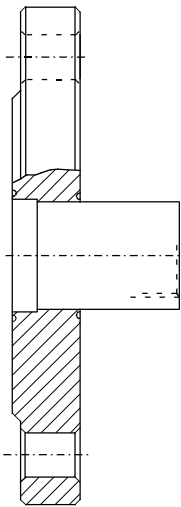

FLANGE TYPE	COUPLING TYPE					
	G1 std.	G1 std. HC	G1 hyg.	G1 hyg. HC	G1 Exi	G1 Exi HC
	ORDER CODE	ORDER CODE	ORDER CODE	ORDER CODE	ORDER CODE	ORDER CODE
DN25 PN40	M548832	M5488323	M548833	M5488333	M548834	M5488343
DN40 PN40	M551267	M5512673	M551268	M5512683	M552361	M5523613
DN50 PN40	M860282	M8602823	M548830	M5488303	M548831	M5488313
DN80 PN40	M860281	M8602813	M548828	M5488283	M548829	M5488283
DN100 PN40	M552364	M5523643	M5523640	M55236403	M5523641	M55236413
ANSI1"150LBS	M552365	M5523653	M5523650	M55236503	M5523651	M55236513
ANSI1"300LBS	M548861	M5488613	M548862	M5488623	M548863	M5488633
ANSI2"150LBS	M552367	M5523673	M5523670	M55236703	M5523671	M55236713
ANSI2"300LBS	M548864	M5488643	M548865	M5488653	M548866	M5488663
ANSI3"150LBS	M551564	M5515643	M5515640	M55156403	M5515641	M55156413
ANSI3"300LBS	M548867	M5488673	M548868	M5488683	M548869	M5488693
ANSI4"150LBS	M552371	M5523713	M5523710	M55237103	M5523711	M55237113
ANSI4"300LBS	M552372	M5523723	M5523720	M55237203	M5523721	M55237213
FOR GASKET CHANNEL : (DIN 2512N)						
DN25 PN40	M548825	M5488253	M548826	M5488263	M548827	M5488273
DN50 PN40	M548822	M5488223	M548823	M5488233	M548824	M5488243
DN80 PN40	M548819	M5488193	M548820	M5488203	M548821	M5488213

Multidimensional flange coupling

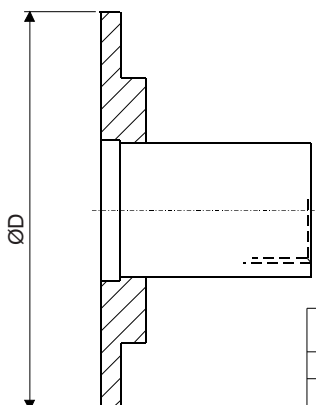

Ø D	COUPLING TYPE					
	G1 std.	G1 std. HC	G1 hyg.	G1 hyg. HC	G1 Exi	G1 Exi HC
	ORDER CODE	ORDER CODE	ORDER CODE	ORDER CODE	ORDER CODE	ORDER CODE
Ø 92	M1050030	M10500303	M1050031	M10500313	M1050032	M10500323
Ø 127	M1050033	M10500333	M1050034	M10500343	M1050035	M10500353

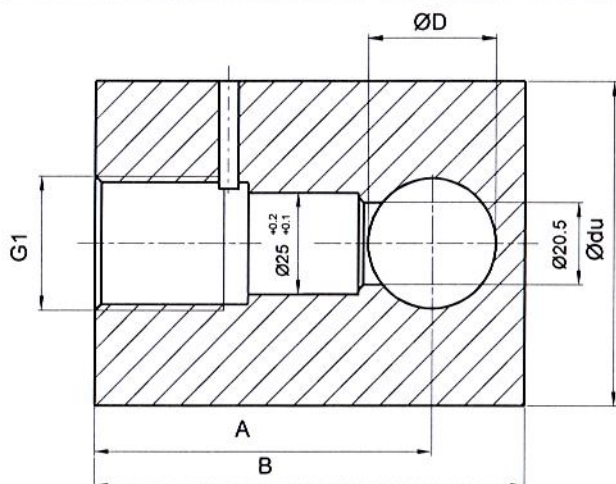

Pipe size	Dim. Ødu	Dim. A	Dim. B	Dim. ØD	Order code	Material
DN15	80	80	96	20 ^{+0.5} / _{+0.2}	M1050303xx	Should be mentioned in the order
DN20	80	83	101	25 ^{+0.5} / _{+0.2}	M1050304xx	Should be mentioned in the order
DN25	80	86	108	32 ^{+0.5} / _{+0.2}	M1050305xx	Should be mentioned in the order
DN32	80	91	117	40 ^{+0.5} / _{+0.2}	M1050306xx	Should be mentioned in the order
DN40	100	95	127	50 ^{+0.5} / _{+0.2}	M1050307xx	Should be mentioned in the order
DN50	100	103	141	63 ^{+0.5} / _{+0.2}	M1050308xx	Should be mentioned in the order

Plastic coupling G1 for plastic pipes DN15 - DN50



Seal for Satron couplings G1. Enables to seal the leaking metal to metal taper.

Order code:
- PTFE T546022

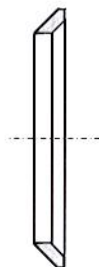

Special adapter for Satron couplings G1. By using this adapter it is possible to install the sensor head ca. 3 mm deep into the coupling.

Order code:
- EN 1.4462 (Duplex) M1050294

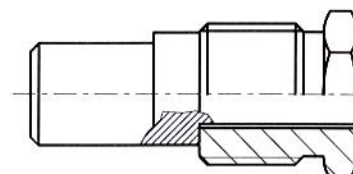

Seal plug assembly for Satron coupling G1. By seal plug the coupling can be closed tightly.

Order code:
- AISI316L M550405

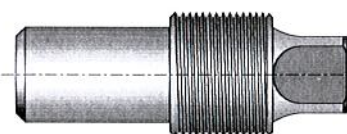

Welding assistant for Satron coupling G1.

It is always recommendable to use the welding assistant while welding the coupling to prevent any distortions due to heat.

Order code:
- Brass M1050420