

SATRON[®]

PREON™ VV Pressure Transmitter

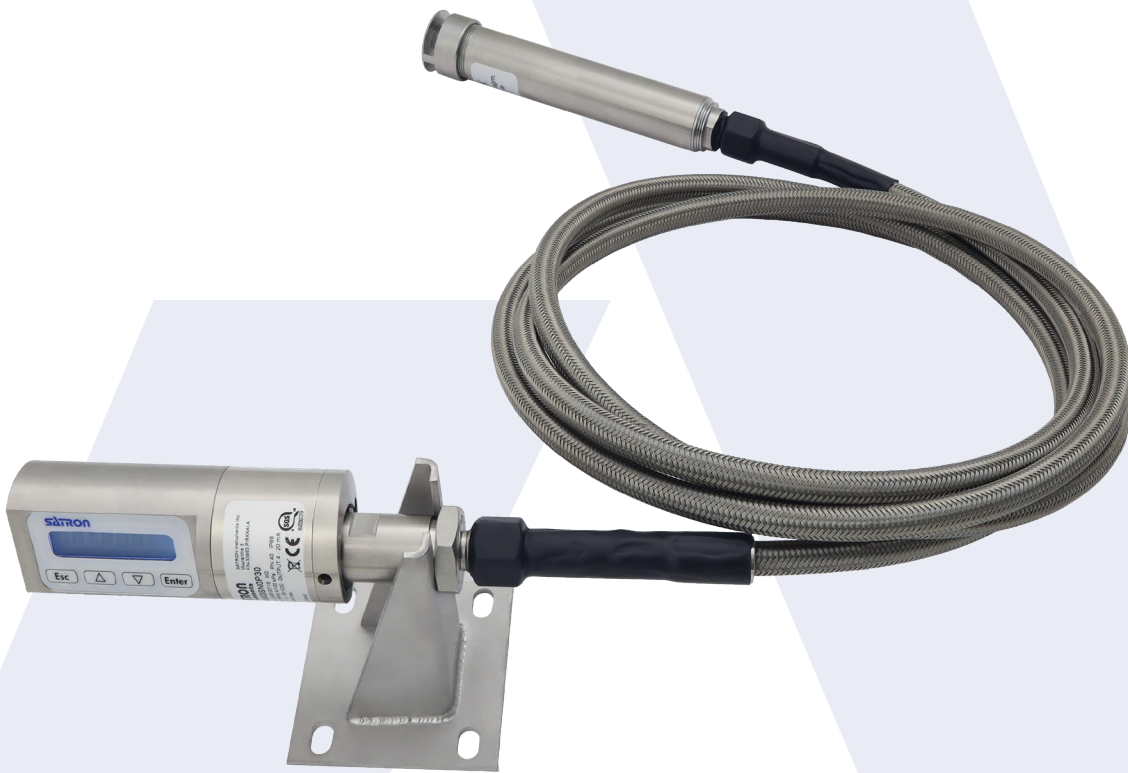

INSTALLATION AND OPERATION INSTRUCTIONS MANUAL

TABLE OF CONTENTS

1 INSTALLATION..... 3
 1.1 MECHANICAL INSTALLATION.....3
 1.2 ELECTRICAL CONNECTIONS.....5
2. DEVICE CONFIGURATION.....7
 2.1 USING THE HART® COMMUNICATOR USER INTERFACE.....7
 2.2 SETTING UP VIA HART® COMMUNICATOR USER INTERFACE.....7
 2.3 DEVICE CONFIGURATION WITH SATRON PADVISOR SERVICE SOFTWARE.....8
3. CALIBRATION10
 3.1 LIQUID LEVEL MEASUREMENT10
4. CONSTRUCTION AND OPERATION10
 4.1 SMART TRANSMITTER10
5. USER’S GUIDE FOR MENUS 11
 V-series (housing type N)11
 5.1 MEASUREMENT MODE MENU: MEASURE.....11
 5.2 CONFIGURATION MENU: CONFIGUR12
 5.3 DEVICE INFORMATION MENU: INFO.....14
 5.4 DIAGNOSTICS MENU: DIAGNOST15
APPENDIX A18

DOCUMENTS

Technical Specifications: BLV810
 Installation and Setting-Up Instructions: BLV810AV

We reserve the right for technical modifications without prior notice.
 HART® is a registered trademark of FieldComm Group, Inc.
 Pasve® is a trademark of Satron Instruments Inc.
 Hastelloy® is the registered trademark of Haynes International.



1 INSTALLATION

VV pressure transmitter is suitable for liquid level measurements in ground and rock tanks, and in open channels and ships' tanks. Transmitters can also be used in corrosive conditions and to measure contaminating liquids.

1.1 MECHANICAL INSTALLATION

Mounting recommendations:

- Process connection direction: vertical
- Cable entry direction: horizontal
- Connector coupling direction, calibration direction:
 - types VVP and VVH: vertical
 - type VVF: vertical or horizontal
 - (equipment cabinet: vertical)

Other considerations:

- Equipment cabinet is recommended for extremely demanding conditions. The equipment cabinet can be provided with heating.
- Freezing of condensed water in reference pressure port must be prevented.
- The opening the rubber cap protecting the filter at the mouth of the reference pressure port must be turned in such direction that any liquid or other material that might block the filter is prevented from accumulating inside the protective cap.

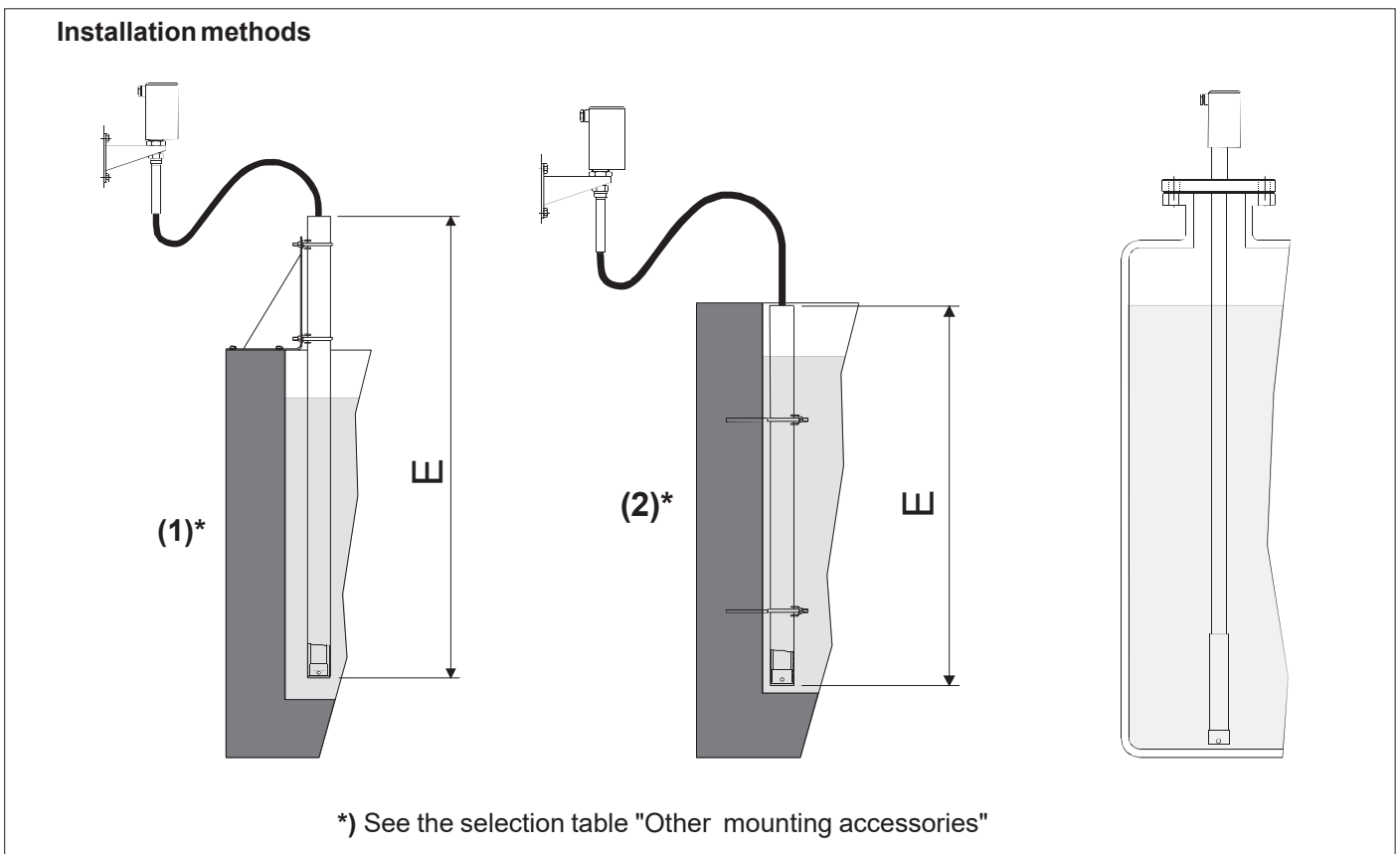

Figure 1-1 Installation methods

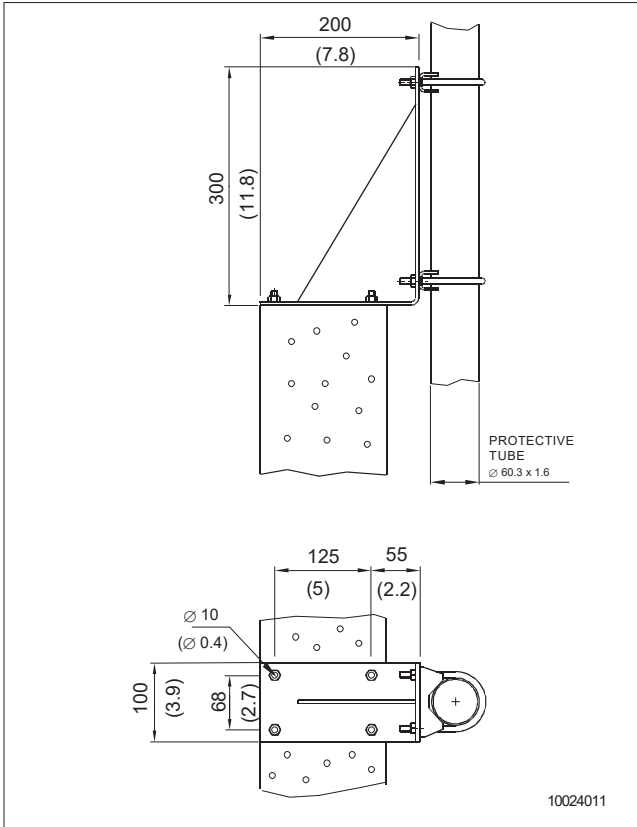

Figure 1-3
Clamp mounting on angle bracket
- mounting accessories code 1

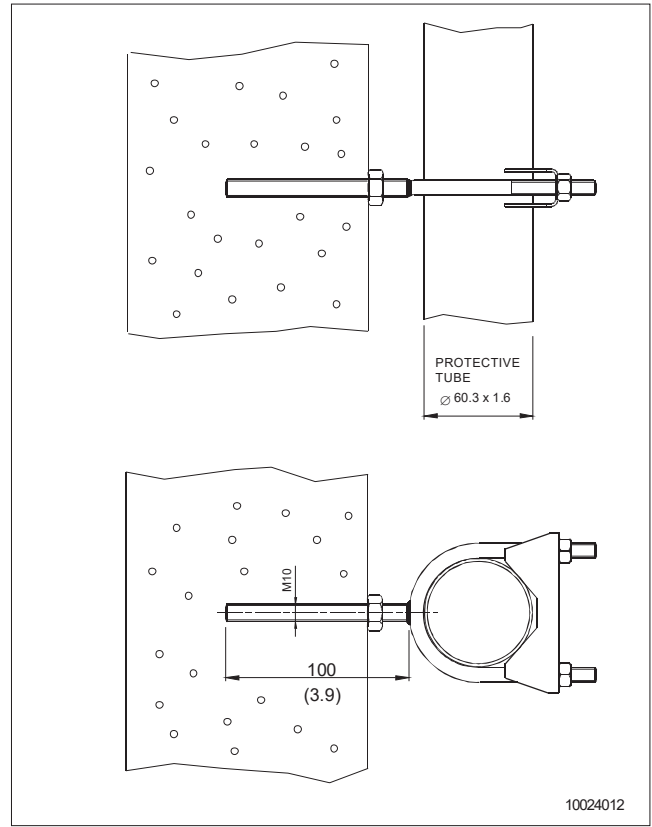

Figure 1-4
Clamp mounting on tank
- mounting accessories code 2

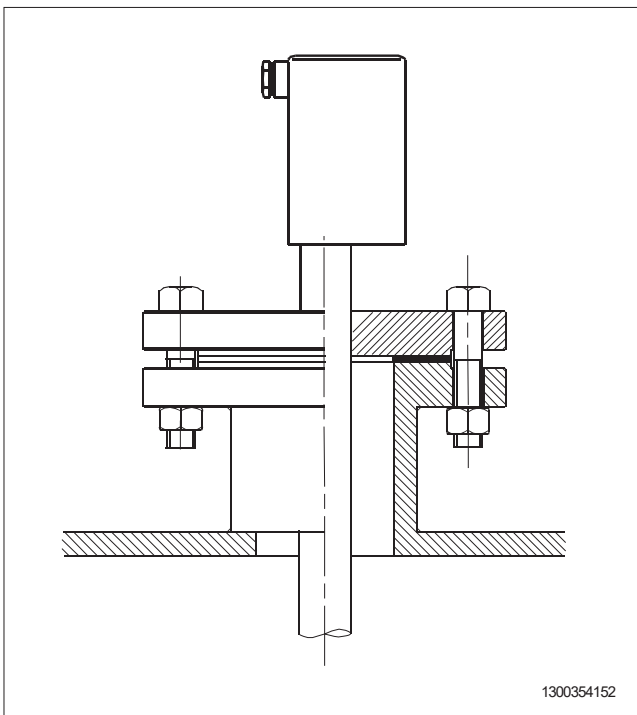

Figure 1-5
Flange mounting without adjustment facility
- type VVH

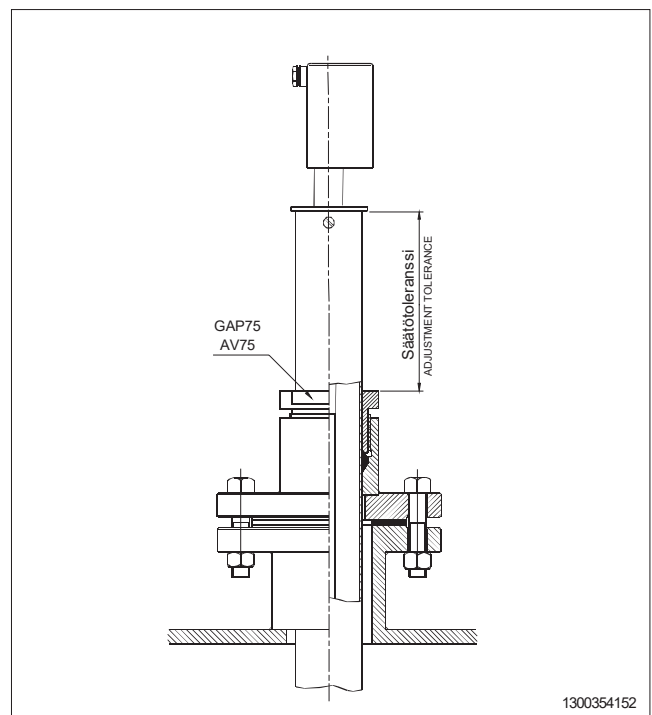

Figure 1-6
Flange mounting with adjustment facility
- type VVP

1.2 ELECTRICAL CONNECTIONS

Supply voltage and load of the transmitter according to the figure 1-8.

We recommend shielded twisted-pair cable as signal cable.

The signal cable should not be installed near high-voltage cables, large motors or frequency converters.

The shield of the cable is grounded at the power supply end or according to the recommendations of the manufacturer of the used control system.

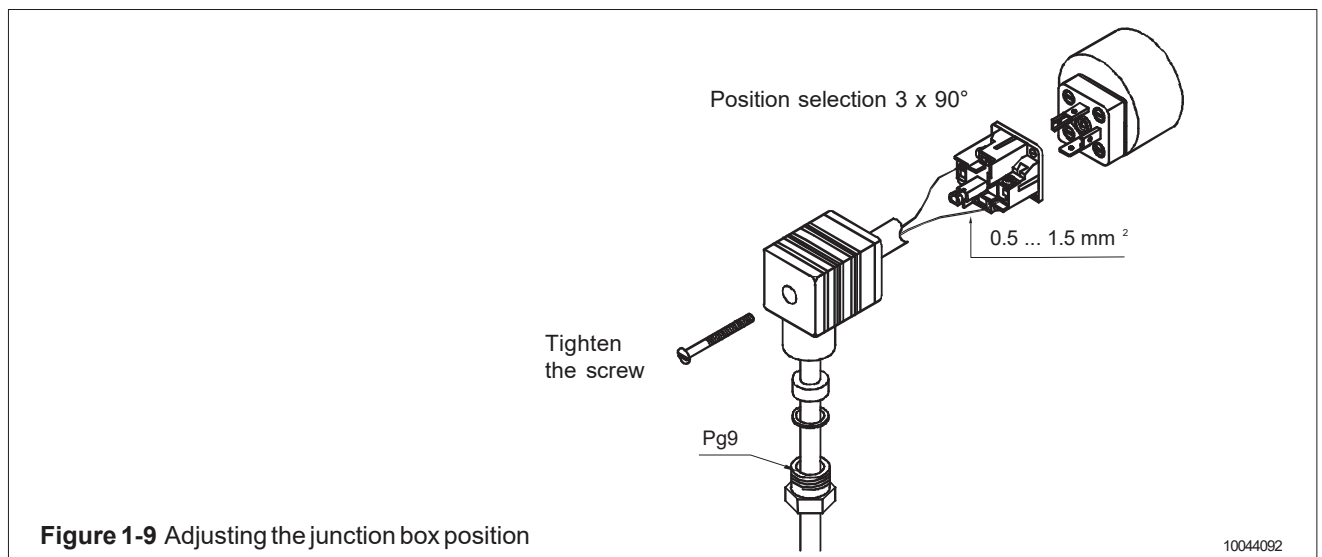
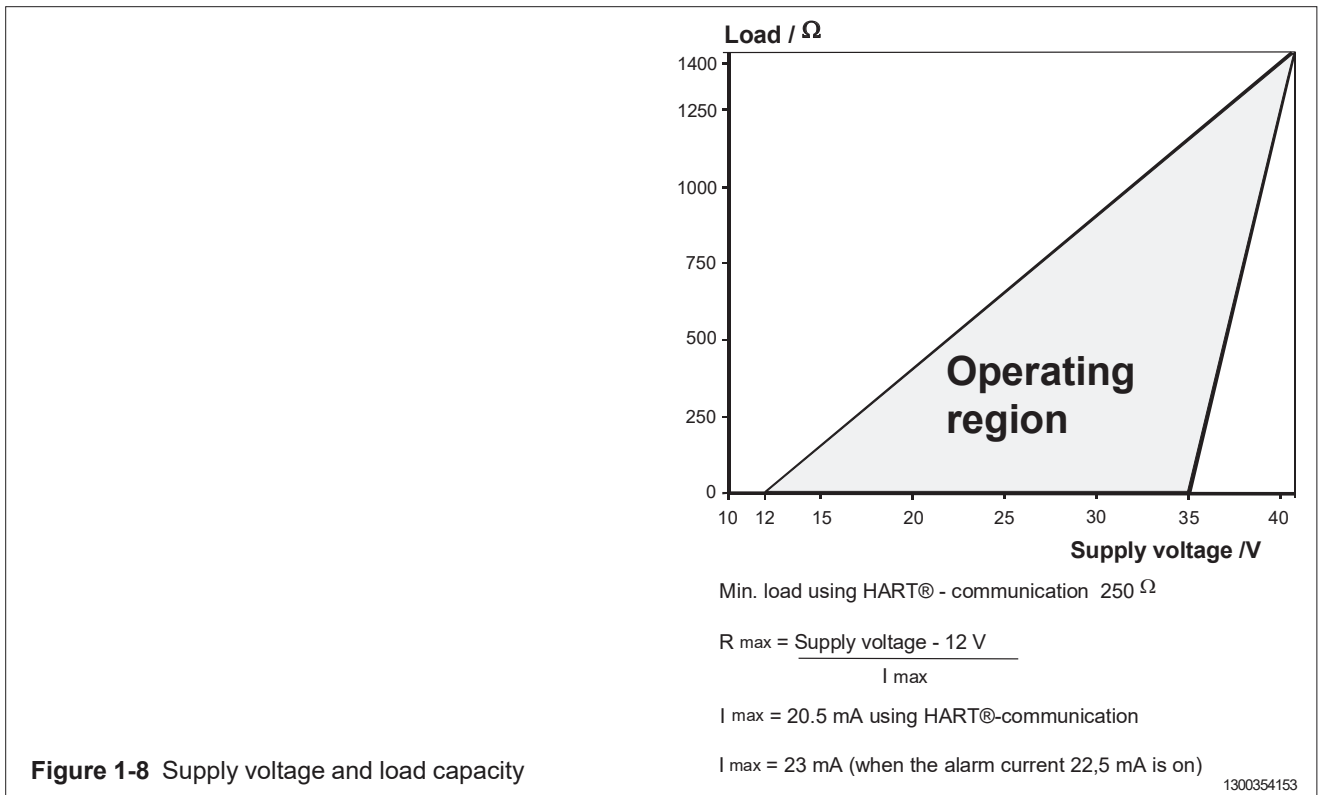
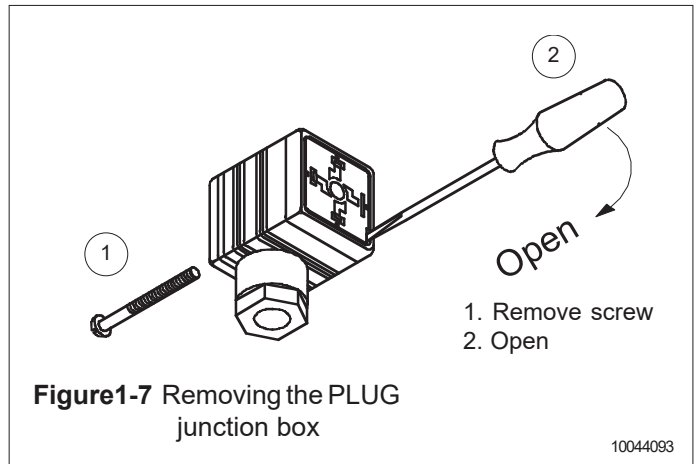

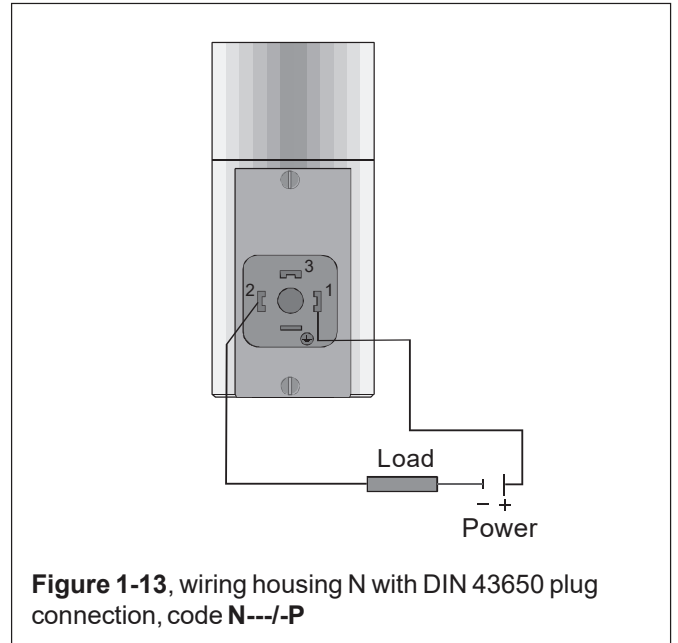
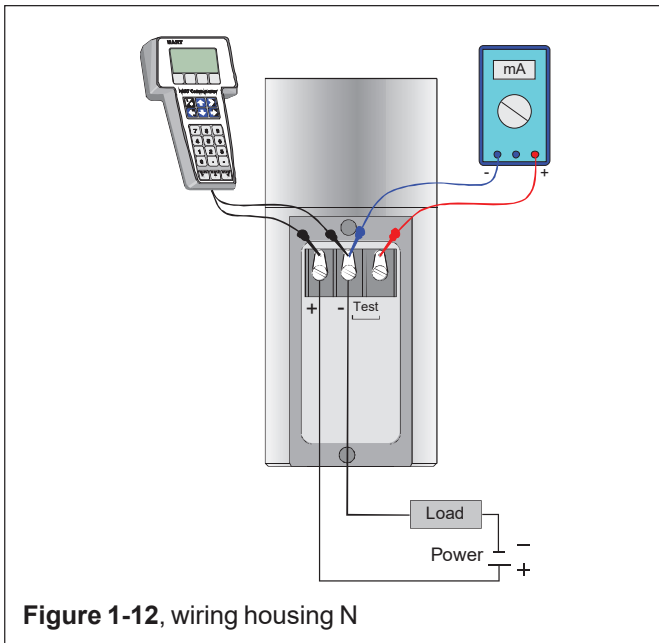
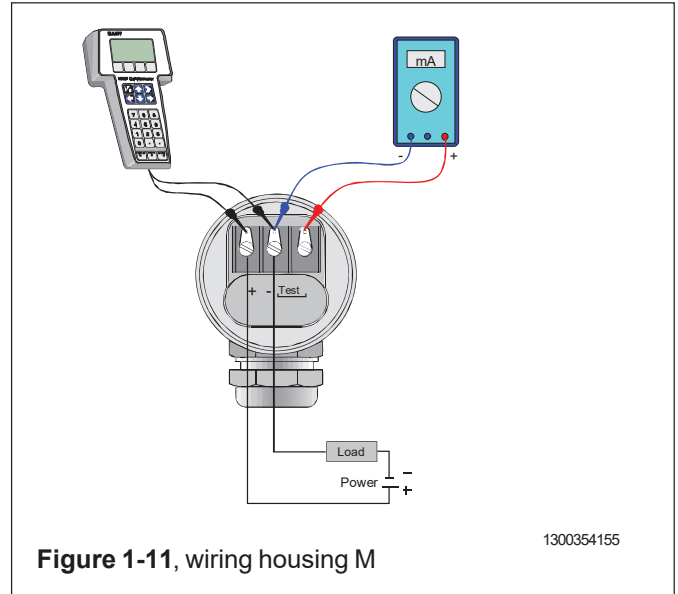
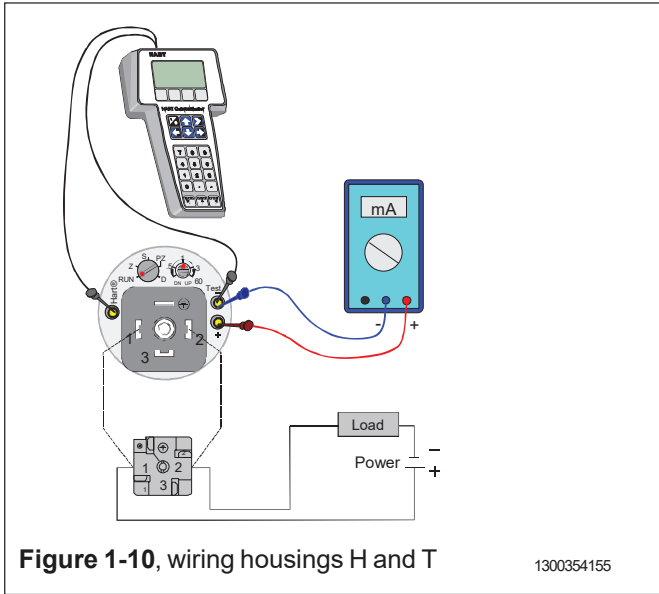

2. DEVICE CONFIGURATION

2.1 USING THE HART® COMMUNICATOR USER INTERFACE



Figure 2-1
375 user interface

Applies to newer models, for example: 475 and AMS TREX device communicator.

2.2 SETTING UP VIA HART® COMMUNICATOR USER INTERFACE

After installing and connecting the transmitter, connect the user interface to the transmitter. The following menu is displayed: **Main menu**. To select the **HART Application**.

The following menu is then displayed:

- 1 Measurement
- 2 Configuration
- 3 Information
- 4 Diagnostics
- 5 Review

To change the measurement unit, damping time constant or output mod, select **Configuration**. The following menu is then displayed:

- 1 Range values
- 2 Output
- 3 Transfer function
- 4 General setup

To change the measurement unit, select **Range values**. The following menu is then displayed:

- 1 LRV
- 2 URV
- 3 LSL
- 4 USL
- 5 Min span
- 6 Apply values

To change the damping time constant, select **Output** from the Configuration menu.

The following menu is then displayed:

- 1 Damping
- 2 Alarm current

To change the output mode, select **Transfer function** from the Configuration menu.

The following menu is then displayed:

- 1 Lin. func
- 2 User function data

After these activities or if the transmitter is supplied with the ready configuration you must correct a zero error of the transmitter in a final installation position.

The First press **Diagnostics** and then **Sensor trim** and then **Zero trim**.

The following text is then displayed : *WARN-Loop be removed from automatic control*

The final zero error correction can be done to select **ABORT** or **OK** on the display.

2.3 DEVICE CONFIGURATION WITH SATRON PADVISOR SERVICE SOFTWARE

Once all Smart Transmitter functions are available, we recommend using the Satron pAdvisor Service Software together with the Satron SI-Tool USB-HART modem for configuration.

Test connections for checking and changing the configuration values and calibrating pressure and current signals including *SENSOR TRIM* operation

Recommended equipment for calibration

Satron-pAdvisor service software for SATRON Smart transmitter (can be loaded free of charge from www.satron.com)

PC: operating system Windows 10 or newer.

DMM: Digital multimeter, basic DCV accuracy better than 0,01 % of reading (for example Fluke 8840A, Keithley 2000)

Cal. pressure generation and measurement device (accuracy better than 0,03 % of reading)

USB-HART® modem, SATRON Si-Tool, code: **M1330002**

Digital multimeter for output current measuring

PC

Cal. pressure generation and measurement device

VV transmitter

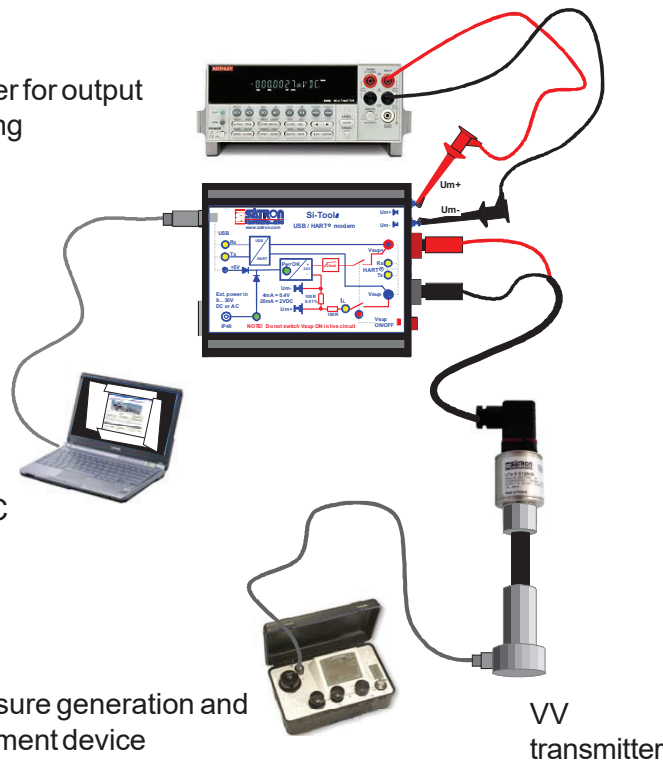
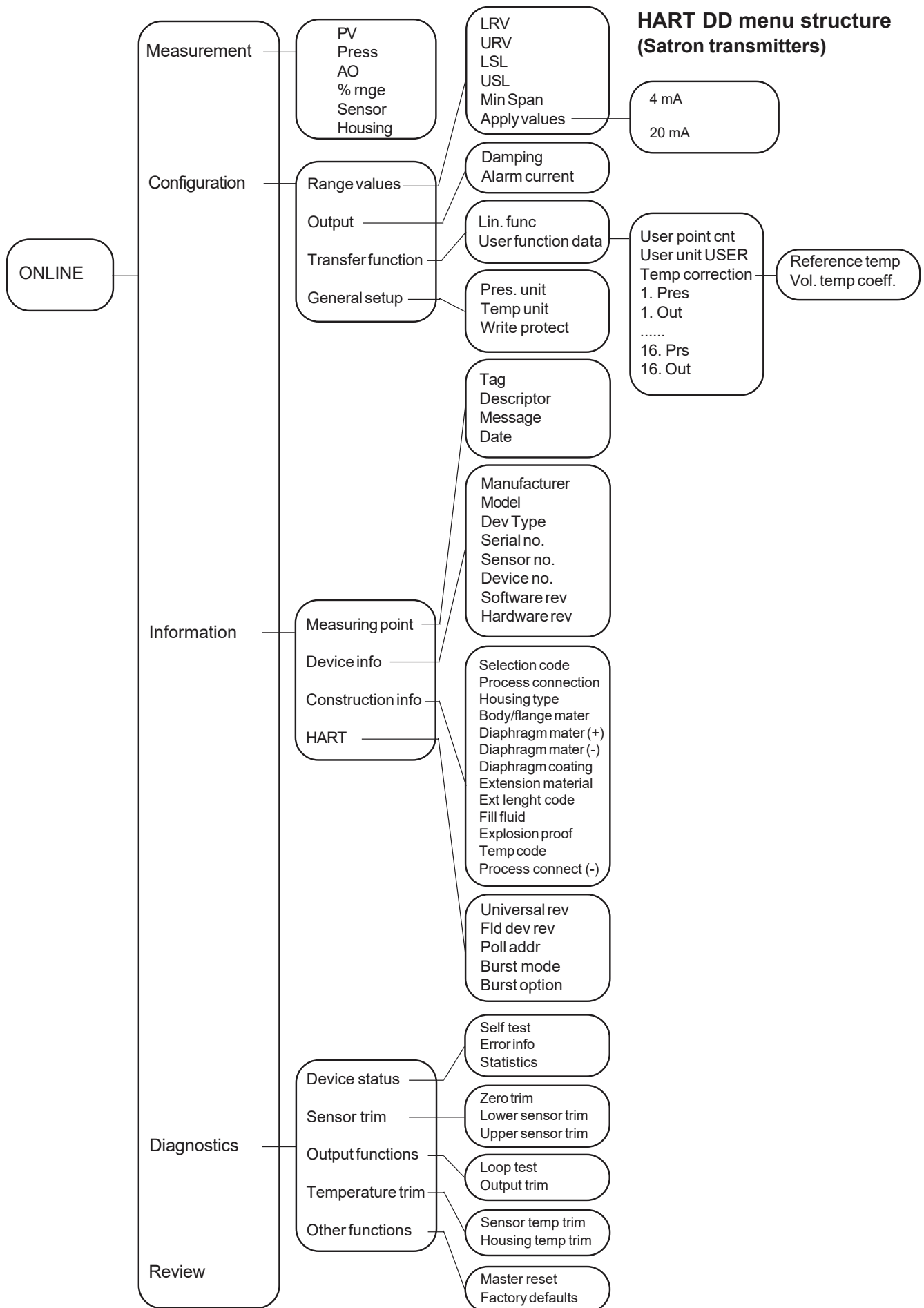

Figure 2-2 Calibration connections window



3. CALIBRATION

3.1 LIQUID LEVEL MEASUREMENT

Open tank

Liquid level measurement with pressure transmitter is based on the measurement of the liquid’s static pressure. Static pressure does not depend on the shape or volume of the vessel. It can be calculated by multiplying the liquid’s density by the liquid level and acceleration of gravity:

$$p = \rho h g$$

where

- p = static pressure
- ρ = density
- h = height of liquid level
- g = acceleration of gravity

The pressure acting on the flange diaphragm is thus directly proportional to the height of the liquid level, and the transmitter can be calibrated to measure liquid level.

The lower limit of the liquid level is normally above the transmitter. This is taken into account through zero suppression.

h_1 = difference between maximum and minimum height of measured level (2.5 m)

h_2 = level’s minimum height from transmitter (1.5 m)

ρ = density of measured liquid (950 kg/m³)

g = acceleration of gravity (9.81 m/s²)

Span (p_1) and zero suppression (p_2) will then be as follows:

$$p_1 = h_1 \cdot \rho \cdot g = (2.5 \text{ m}) (950 \text{ kg/m}^3) (9.81 \text{ m/s}^2) = 23.3 \text{ kPa}$$

$$p_2 = h_2 \cdot \rho \cdot g = (1.5 \text{ m}) (950 \text{ kg/m}^3) (9.81 \text{ m/s}^2) = 14.0 \text{ kPa}$$

$$\text{Measuring range} = p_2 \dots (p_2 + p_1) = 14 \text{ kPa} \dots 37.3 \text{ kPa} \\ (140 \text{ mbar} \dots 373 \text{ mbar})$$

4. CONSTRUCTION AND OPERATION

4.1 SMART TRANSMITTER

Sensor Module

The piezoresistive sensor, which has a silicone oil fill, is isolated from the process with a diaphragm. Sensor pressure and temperature are measured with a 24-bit AD converter. Linearity and temperature effects are digitally corrected with an internal microprocessor connected to the sensor module.

The **sensor** converts pressure to electrical signal. The conversion is carried out through a Wheatstone bridge supplied with direct current. The elastic displacement produced in the bridge by the pressure causes bridge unbalance which is measured as a DC voltage signal.

Compensation includes temperature compensation and linearization. Each sensor is calibrated individually through a resistance network connection. The temperature information required by compensation is derived from a temperature measuring element located by the Wheatstone bridge.

Electronics Module

The electronics module converts the process pressure signal from the sensor module to 4–20 mA output signal. The conversion can be made in linear, square root or inverted mode, or it can be done through user-selectable pressure/output point pairs (2–16 points).

Transmitters provided with own display (code **N**) is equipped with operating keys that allow you to define the transmitter’s all functions.

The active functions required for **signal shaping** are in a customized IC which is divided into two sub-blocks: amplifier block and standard-signal shaping block. The standard-signal shaping block also includes zero, span and damping adjustments.

The **interface stage** includes failure protections to ensure the transmitter’s operation and nonfailure in possible failure conditions. This stage also includes the TEST and cable connections

5. USER'S GUIDE FOR MENUS V-SERIES (HOUSING TYPE N)

The user interface for the V-series transmitters, housing option **N**, consists of display and operating keys. Among other things, the user interface allows you to set process variables in the desired units on the display and to configure the transmitter e.g. by setting the lower and upper range-values (LRV, URV) and the process variable's unit and tag code. In addition, you can perform diagnostic routines and view device information through the user interface.

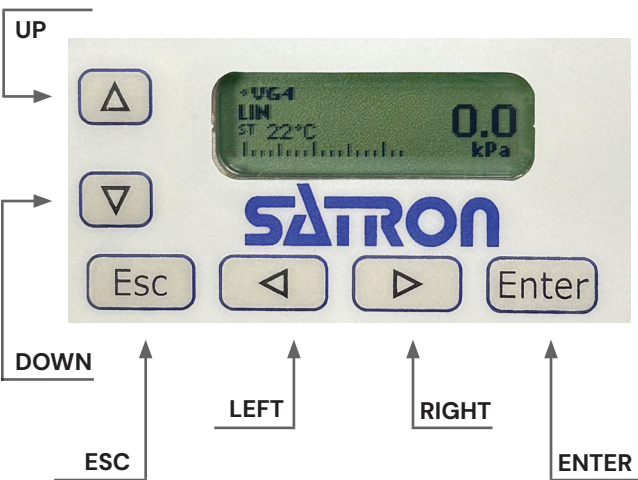

OPERATING KEYS:

With the **LEFT/RIGHT**[←→] and **UP/DOWN** [↑↓] arrow keys and **ENTER** and **ESC** you can move in the menus. The functions of the keys:

LEFT [←]:

Use the **LEFT** arrow key to move left on the current menu level.

RIGHT [→]:

Use the **RIGHT** arrow key to move right on the current menu level.

UP [↑]:

Use the **UP** arrow key to increase the selected parameter value.

DOWN [↓]:

Use the **DOWN** arrow key to decrease the selected parameter value.

ENTER:

Press **ENTER** to accept a command or parameter value and to enter the current menu.

ESC:

Press **ESC** to go to the submenus and to move back towards the previous level and to the top of the main menu.

The main menu has 4 submenus: Measurement, Configuration, Info and Diagnostics menus. When the transmitter is powered up it will go to the Measurement menu's main display, i.e. Process Value.

5.1 MEASUREMENT MODE MENU: MEASURE

When the transmitter is powered up, it immediately shows the **MEASURE** menu's main display. The menu does not have any variables adjustable by the user.

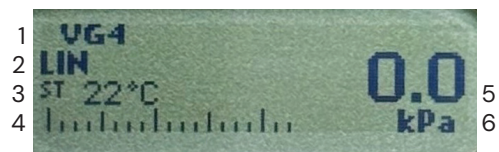

1.1 DEVICE TYPE:

For example, VG4.

1.2 LIN:

The LIN at the left of the display specifies the linearization function in use. The available options are as follows:

LIN	Linear
LIN ZERO	Zero-based linear
INV LIN	Inverted linear
SQRT	Square root
USER LIN	User 16 points

Define the linearization function by selecting **LIN FUNC** from the **CONFIGUR** submenu.

1.3 ST:

Sensor temperature in °C or °F (e.g. 22°C). Select the unit from the **CONFIGUR** submenu.

1.4 MEASUREMENT GRAPHIC:

Graphic mA scale that goes up and down according to the measurement changes.

1.5 PROCESS VALUE:

This shows the PV (process value/primary variable) which may be pressure, volume, differential pressure, etc. (e.g. 0.0).

1.6 PRESSURE UNIT:

The unit of the pressure detected by the sensor (e.g. kPa).

Use the **LEFT/RIGHT**[←→] keys to move in the menu. Moving **RIGHT** you will find the following variables.

1.8 P, PRESSURE VALUE

The pressure detected by the sensor.

1.9 IOUT

Current signal's value in milliamps (mA).

1.10 %, PERCENT

Current signal's value in per cents (%) of full-range value.

1.11 ST, SENSOR TEMPERATURE

Sensor temperature in °C or °F. Select the unit from the **CONFIGUR** submenu.

1.12 ET, ELECTRONICS TEMPERATURE

The temperature of the transmitter's electronics, either °C or °F. Select the unit from the **CONFIGUR** submenu.

1.13 SN

The transmitter serial number.

The top row of the graphic display shows information and can include icons. Their meanings are explained below.

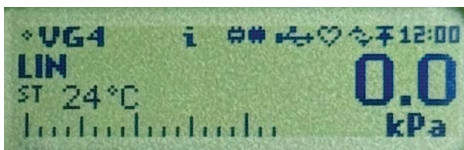

- ❖ **Blinking dot:** indicates that CPU and display are fine.
 - VG4:** informs the device type.
 - i** Depends on the status information:
 - A static i indicates a warning or noncritical error, with the measurement value blinking. It can also signal an unacknowledged inactive error bit.
 - Exclamation mark '!' and 'mA' indicate a critical error (alarm current is active).
 - Otherwise, device status is empty.
 - When data or event is being logged into memory.
 - When EEPROM is being written.
 - USB communication active.*
 - HART communication active.
 - IO-Link communication active.*
 - Upload symbol: when log is being read.
 - Download symbol: when firmware is being updated.
 - 12:00** RTC HH:MM (if Real Time Clock is activated).*
- *Not yet available with PREON.

5.2 CONFIGURATION MENU: CONFIGUR

Go to the Configuration mode from the main menu level pressing the **ESC** key and then **RIGHT** arrow. Then press **ENTER** to access the **CONFIGUR** submenu. In this submenu you can define the upper and lower range-values (**URV**, **LRV**), device identification code, linearization function, etc. Use the **ESC** key to exit the **CONFIGURATION** menu to the main menu.

2.1. MANUFCTR

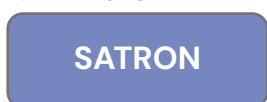

Manufacturer's name.
Cannot be changed.

2.2. DEV TYPE



Product type code.
Cannot be changed

2.3. TAG



Tag code. You can enter free format text one character at a time. When you select this option

with **ENTER** the cursor will be at the left. Select characters with **UP/DOWN**[↑↓] keys. You can view the selectable characters one character at a time with the **UP/DOWN**[↑↓] keys until the desired character is found and then move right to select the following characters. When the cursor is at the right edge you can save the tag code pressing **ENTER** or go back to the **CONFIGUR** menu without changing the tag code by pressing **ESC**. You can go back to edit mode by pressing the **ESC** key when asked to save your entry. Apostrophe indicates the cursor position; at point, however, the cursor will disappear. A great deal of special characters are available besides letters and numbers.

2.4 PV URV, UPPER RANGE VALUE

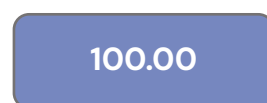

This is the process variable's upper range-value corresponding to 20

mA. Set the value in the selected units, which are displayed first. The numerical value is shown in the next screen where you can also edit the value. The procedure is similar to **TAG**, except that you first set the position of the decimal point with the **LEFT/RIGHT**[←→] keys. After accepting that with **ENTER** you can edit each digit in the value in the same way as the characters in **TAG**. If the defined upper range value is invalid, the display will blink and you go back to re-edit the value.

2.5 PV LRV, LOWER RANGE VALUE



Here you set the process variable's lower range value corresponding to 4 mA. The procedure is the same as for upper range value.

2.6 PV DAMP, DAMPING



Time constant, in seconds, for output damping. The range is 0.025s to 60s. Set the value with the **UP/DOWN**[↑↓] keys and accept it with **ENTER**, or press **ESC** if you do not want to change the value.

2.7 PV UNIT

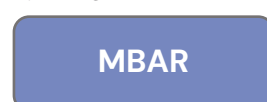

Here you can display or change the applied unit of measure. Press

ESC to exit without making a change. Press **ENTER** to accept new value. Use the **LEFT/RIGHT**[←→] keys to view the units. The selectable units include **KPA**, **TORR**, **ATM**, **MPA**, **INH2O**, **INHG**, **FTH2O**, **MMH2O**, **MMHG**, **PSI**, **BAR**, **MBAR**, **G SQCM**, **KG SQCM**, **PA**.

2.8 T UNITS



Select the temperature unit from this menu. The unit can be °C or °F.

Proceed as described above to make the selection.

2.9 LANGUAGE

ENGLISH

From this menu you can select the desired language (**SUOMI, SVENSKA, ENGLISH, DEUTSCH or FRANCAIS**). Use the **LEFT/RIGHT[←→]** keys to select the language, press **ENTER** to save the selection, or press **ESC** to exit without saving.

2.10 PASSWORD

12

From this menu you can set a password (0..999) for the transmitter. If a password has been specified, you cannot set any parameters or make any other settings on the transmitter unless you enter the correct ID number in this menu. Password is not in use when **PASS-WORD** is 000 after reset. You enter the **PASSWORD** in the same way as **TAG**. **PASSWORD** will be on when you define a value between 1 and 999. If you forget password get in contact with Satron Instruments Inc.

2.11 LRV=PV

0.000000

Here you set the current process pressure as lower range value (**LRV**). Accept the setting with **ENTER** when asked to confirm the value (**SAVE?**). Press **ESC** to exit if you do not want to change the value. Compare this function to **LRV**. Blinking value indicates an error, i.e., measured pressure is lower than the sensor's lower range value or the difference between upper and lower range values is not on the specified range.

2.12 URV=PV

90.00000

Here you set the current process pressure as upper range value (**URV**). Accept the setting with **ENTER** when asked to confirm the value. Press **ESC** to exit if you do not want to change the value. Compare this function to **URV**. Blinking value indicates an error, i.e., measured pressure is higher than the sensor's upper range-value or the difference between upper and lower range-values is not on the specified range.

2.13 LIN FUNC

LIN FUNC

In this menu you select the output transfer function for current loop connection. The selection is done with the **LEFT/RIGHT[←→]** keys. The standard **LIN** function is used 99% of the cases.

LIN: Linear 4mA to 20mA [PV (Process Value) is the current measured value indicated on the display and via HART® (value measured by sensor)].

Other options, for specific cases, are as follows:

- LIN ZERO:** Linear 4mA to 20mA. PV (Process value) displayed on transmitter display and HART® is scaled to display Zero at LRV.
- INV LIN:** Inversely linear 20mA to 4mA.
- SQRT:** Square root 4mA to 20mA. Commonly used for flow measurement calculated from pressure drop over a flow restrictive device.
- USER LIN:** User-defined 16-point interpolated transfer function for output. Enter the points through the **USER FUNCTION** option or through **HART®** user interface.
- USER SPL:** The same as **USER LIN**, but this generates a smoother transfer function for the output.

2.14 HART® COMMUNICATION LINK SETTINGS

HART

Select this function with the **LEFT/RIGHT[←→]** keys. In menus 1-3 you select the content of the burst message. You can view the available selections with the **LEFT/RIGHT[←→]** keys.

Available options:

In menu 1 (PV): Transmitter sends process value PV to system.

In menu 2 (PERCEN%): Transmitter sends process variable's value in per cent of specified measuring range to master.

In menu 3 (PVS/CURR): Transmitter sends all process variables and current signal's value.

In menu 5 (POLL ADR): Select the transmitter's Hart® address. The address can be set between 0 and 15. Address 0 defines current loop, in which case the transmitter will operate in two-wire system. The procedure is the same as described above.

In menu 6 (BURST ON/OFF): Select the Burst mode. First define the process variable sent by the transmitter from menus 1-3. The procedure is the same as described above.

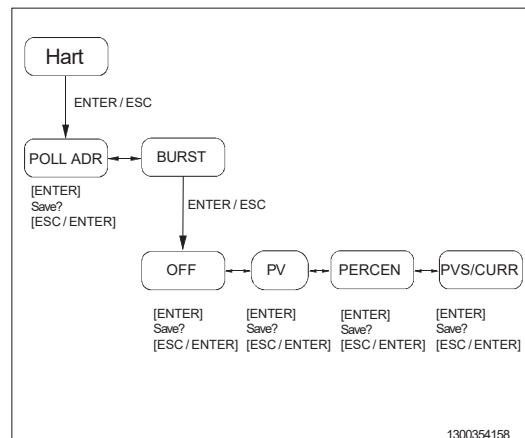

2.15 ALRM TYP

3.7 MA

Current signal will settle at either 3.7 mA or 22.5 mA to indicate transmitter fault to an external device. Use the **LEFT/RIGHT**[←→] keys to select the current value from the menu. The default is 3.7 mA.

2.16 DATE

09092024

The date consists of a single field. For instance, 09092024 specifies 09 September 2024. You can edit the date in form ddmmyy. The calendar year can be selected from between 1900 and 2155. This date can be example date of calibration.

2.17 USER.PNTS

POINTS

In this menu you define the points for a user-defined function. You enter the pressure and corresponding output point by point. The number of points is at least 2 and at most 16. In this connection you can also define the corresponding reference temperature **T REF** and volume's temperature coefficient **V T COF**. Select and accept the numerical values as described above. Set the pressure and the corresponding output. Make the settings one character at a time in the same way as when defining **TAG**. Press **ESC** to return to the **CONFIGUR** menu. Press **ENTER** to edit the selected variable. Use the arrow keys to select the desired variable. The selectable variables include the following:

POINTS	volume of couple of points (2...16)
UNITS	unit (max. 8 markers)
PRES 0	1st reference pressure
OUT 0	Output corresponding to 1st reference pressure at reference temperature
PRES 1	2nd reference pressure
OUT 1	Output corresponding to 2nd reference pressure at referencetemperature
.	
.	
PRES 15	16th reference pressure
OUT 15	Output corresponding to 16th reference pressure at reference temperature
T REF	Reference temperature
V T COF	Volume's temperature coefficient You can change the variables in the same way as TAG

2.18 DISPLAY

DISPLAY

In this menu you can select the direction in which the display will be read:

NORMAL: From left to right. Transmitter mounted horizontally with process connection directed to the right.
ROTATED: Rotates the text 180 degrees from NORMAL.

2.19 BACKLIGHT

BACKLIGHT

In this menu you select the backlight on / off. The selection is done with the arrow keys, and the options are as follows:

MODE:

OFF	Backlight off
DELAYED	Backlight on for 60 s after the start.
BUTTON	Backlight on for 60 s for the last button is pressed,

BLINK:

OFF	Backlight blink off.
------------	----------------------

COLORS:

ENABLED	Enable different colors. The display color will change to RED if there is an alarm or error in the transmitter and to BLUE when reading the transmitter log data.
DISABLED	Disable different colors.

5.3 DEVICE INFORMATION MENU: INFO

You can select the device information menu from the Main Menu level with the **ENTER** key. In this submenu you can view the upper and lower range-values (**URV, LRV**), device ID number, sensor's upper and lower scale-limits (**USL, LSL**), etc. Use the **LEFT/RIGHT**[←→] keys to view these items. Press **ESC** to return to the Main Menu level. You cannot change the data displayed in this menu.

3.1 MANUFCTR:

SATRON

The manufacturer of the transmitter.

3.2 DEV TYPE

VG4

Product type code. E.g. VG4.

3.3. TAG

PI-206

Tag code. E.g. PI-206.

3.4 PV USL

100.0000

Sensor's upper scale-limit in the selected units. Press **ENTER** to select this item. The configured unit will be displayed when you press **ENTER** a second time.

3.5 PV LSL

000.0000

Sensor's lower scale-limit in the selected units. The procedure is the same as for **USL**.

3.6 MIN SPAN

4.00000

Minimum span. Press **ENTER** to select this item. Press **ENTER** a second time to display the unit. Press **ESC** to exit.

3.7 ASSM NUM

2407

The transmitter's assembly number. Press **ENTER** to select this item. Press **ESC** to exit. For instance, assembly number 2407 shows that the transmitter was made in week 07 of the year 2024.

3.8 PV SNSR

N 79565

The sensor's serial number. Press **ENTER** to select this item. Press **ESC** to exit. E.g. N 79565.

3.9 VERSION

11

Version numbers of the transmitter's electronics and software. Press **ENTER** to select this item. Press **ESC** to exit. With the **LEFT/RIGHT**[←→] keys you can select either **CPU HW**, **CPU SW**, **CPU FW**, **ADC HW**, **CPU ID** or **MAN REV** (manual revision) revision number or **CPU ID** number from this submenu.

3.10 OP TIME

11:36:52

The value of the operation time save at 1 hour intervals. When the value of the counter is < 100 hours so value save 1 minute intervals.

The value of the operation time counter on the display :
HH : MM : SS when the value of counter is <100 hours
HHHH : MM when the value of counter is <100000 hours
HHHHHHHH when the value of counter is ≥100000 hours

5.4 DIAGNOSTICS MENU: DIAGNOST

Select the **DIAGNOST** menu on the Main Menu level with the **ENTER** key. This submenu allows you to examine the transmitter's internal errors and faults, to set the transmitter to give out a fixed current, and to calibrate the transmitter.

4.1 STATUS

DEVICE OK

Here you can display and reset accumulated errors one at a time. The text **DEVICE OK** will be displayed if there are no errors. Possible error messages (alarm means a serious fault/error that also puts the current signal in fault status and makes the display blink).

4.2 LOOP TST

LOOP TST

The transmitter can be set to give out a fixed current signal for testing the mA output. The first **ENTER** will switch the transmitter off from normal mode (**AUTO OFF**), the second **ENTER** will set it for 4 mA output, and the third **ENTER** for 20 mA output. The next **ENTER** after that will give default value 12 mA, which can be changed as desired with the **UP/DOWN**[↑↓] keys. The last **ENTER** will switch the transmitter back to normal mode (**AUTO ON**). The purpose of this test is to test the accuracy of the transmitter's current output with a reference meter. If any shortcomings are detected, refer to **4.3 LOOP CAL** for calibrating the mA output.

4.3 LOOP CAL

LOOP CAL

Here you can calibrate the current signal given by the transmitter. The first **ENTER** will switch the transmitter off from normal mode (**AUTO OFF**). The next **ENTER** will make the transmitter give out a signal which it assumes to be 4 mA. Use the **UP/DOWN**[↑↓] keys to change this value in accordance with the reading on the reference meter. Then press **ENTER** for 20 mA output, which you must also set in accordance with the reference meter. Press **ENTER** to accept the new reading. **Note:** Use a sufficiently accurate reference meter.

4.4 SENS.TRIM

SENS.TRIM

Here you can calibrate the pressure values. Pressing **ENTER** will display **LWR.TRIM**, where you give the measured value for the sensor's lower calibration pressure. In the next display, **UPR.TRIM**, you give the measured value for the sensor's upper calibration pressure.

The procedure:

- Apply a pressure corresponding to the desired **LRV** (lower range-value).
- Select **DIAGNOST /SENS.TRIM**. Pressing **ENTER** will now display **LWR.TRIM**, and the next **ENTER** will show the pressure reading.
- Use the **UP/DOWN[↑↓]** keys to adjust the displayed pressure in accordance with the reference meter's pressure reading as described in **2.4 UPV**.
- Press **ENTER** to accept the adjusted reading, or press **ESC** to exit without saving the value.
- Apply a pressure corresponding to the desired **URV** (upper range-value).
- Pressing **ENTER** will display **UPR.TRIM**. The next **ENTER** will display the measured pressure.
- Use the **UP/DOWN[↑↓]** keys to adjust the displayed pressure in accordance with the reference meter's pressure reading.

NOTE!

The difference between **LWR.TRIM** and **UPR.TRIM** must be at least the transmitter's minimum span.

4.5 PV ZERO

PV ZERO

Here you can reset the transmitter. Pressing **ENTER** will display **PV=ZERO?**. Pressing **ENTER** a second time will display **SAVE?** The transmitter will be reset if you press **ENTER** after that.

4.6 EL-DIFF

EL-DIFF

Displays all available pressure variables and the related sensor information.
(Normal pressure and differential pressure transmitters include only P1 and 1st sensor's information but VDUs extend to variables P1, P2, P1-P2, P2-P1 and 2nd sensor's information).

4.7 HARDWARE

HARDWARE

VOLTAGES: Internal voltage levels.

DISPLAY: Automatic display and push buttons' test function.

4.8 SET FD

SET FD

Restores the Factory Default Settings. If the Factory Default Settings are not stored in the memory, the menu will display N/A.

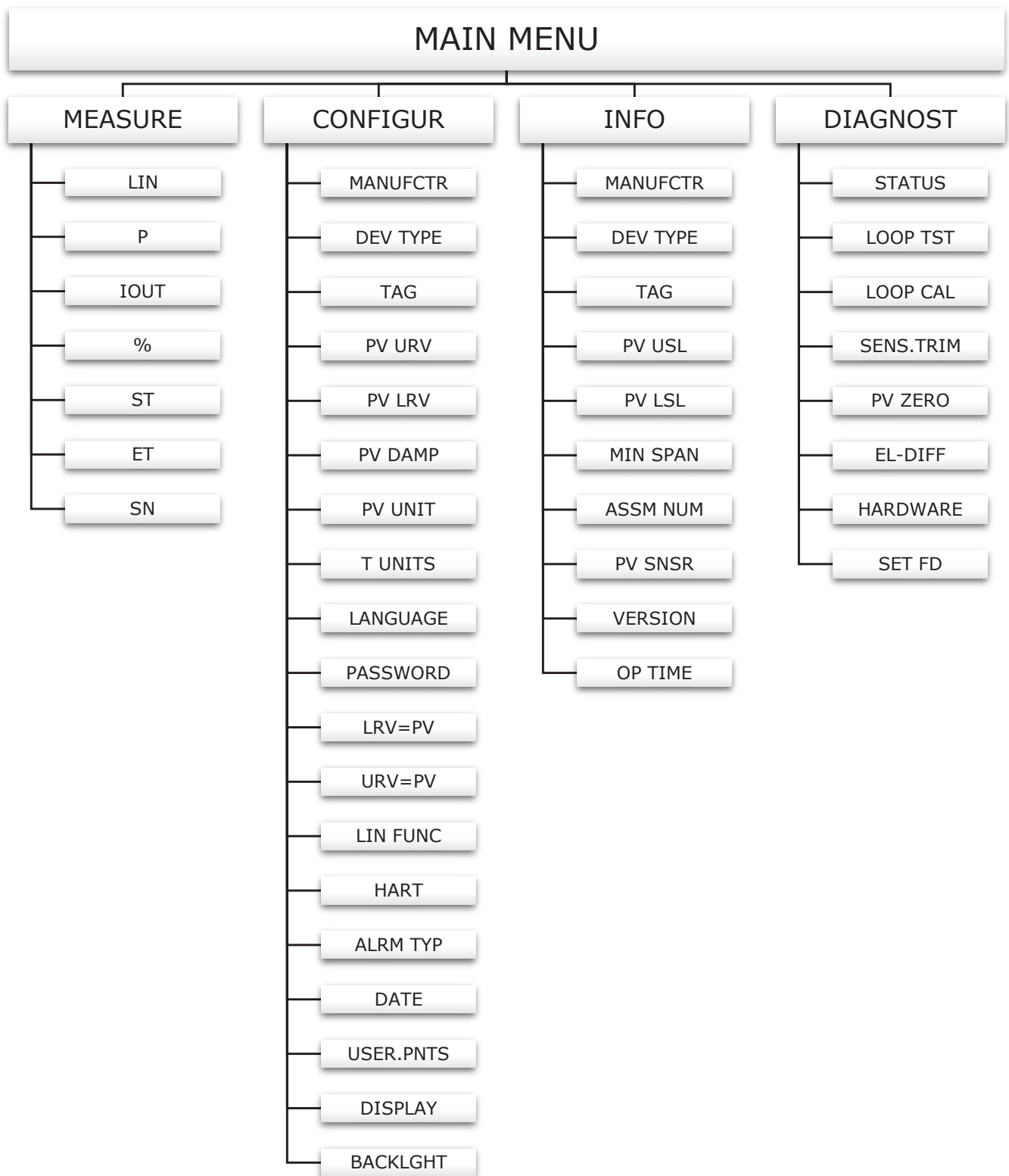

APPENDIX A

ERROR WORDS

The content of error words 1...12.

EW number	EW bit	EW name (function)	Description
01	00	EW1	Turbidity / Consistency error (TU ER/CS ER)
"	01	"	Sensor temperature error (ST ER)
"	02	"	Electronics temperature error (ET ER)
"	03	"	Output under -10 % or over 110 % (RANGE ER)
"	04	"	Output current saturated (OUTSA WA)
"	05	"	ADC runtime error (ADCR ER)
"	08	"	ADC startup error (ADCS ER)
"	09	"	EEPROM read error (EERPR ER)
"	10	"	EEPROM write error (EERPW ER)
"	11	"	EEPROM calibration error (EECAL ER)
"	12	"	HART error (HART ER)
"	13	"	System error (INTRN ER)
02	02	EW2	Overfeed timer (OFTMR ER)
"	04	"	ADCA error
"	05	"	ADCB error
"	06	"	DACA error
"	07	"	DACB error
"	08	"	DISP error
"	09	"	EEPR error
"	10	"	HARA error
"	11	"	HARB error
"	12	"	SYSA error
"	13	"	SYSB error
03	00	ADCA (A/D, LEDs)	ADC not found
"	01	"	Comm error
"	02	"	Invalid channel
"	03	"	Irpt timeout
"	04	"	Gain comm error
"	08	"	AINM undervoltage
"	09	"	AINM overvoltage
"	10	"	AINP undervoltage
"	11	"	AINP overvoltage
"	12	"	ADC saturation
"	13	"	ADC conversion error
"	14	"	Miscellaneous error
04	08	ADCB (")	LED comm1 error
"	09	"	LED comm2 error
"	10	"	LED short error
"	11	"	LED open error
05	00	DACA (D/A, I/O)	IOOUT not connected
"	01	"	Comm timeout
"	02	"	Frame error
"	04	"	VLoop 12V
"	05	"	VLoop 6V
"	06	"	Temp 100C
"	07	"	Temp 140C
"	08	"	ILoop under
"	09	"	ILoop over

"	12	"	Loop error
"	13	"	I/O comm error
06	00	DACB (")	IOOUT2 not connected
"	01	"	I2 Comm timeout
"	02	"	I2 Frame error
"	04	"	I2 VLoop 12V
"	05	"	I2 VLoop 6V
"	06	"	I2 Temp 100C
"	07	"	I2 Temp 140C
"	08	"	I2 ILoop under
"	09	"	I2 ILoop over
"	12	"	I2 Loop error
"	13	"	I/O comm2 error
07	00	DISP (Display, RDU)	Keyb error
"	01	"	Disp error
"	08	"	No reply
"	09	"	Frame error
"	10	"	Checksum error
"	12	"	Keyb error (R)
"	13	"	Timeout error (R)
"	14	"	Frame error (R)
"	15	"	Checksum error (R)
08	00	EEPR (EEPROM, Flash)	Checksum error
"	01	"	Calibration error
"	08	"	CPU r/w error
"	09	"	Log r/w error
"	10	"	ADC r/w error
"	11	"	I/O r/w error
"	12	"	CON r/w error (R)
09	00	HARA (HART, USB, IO-Link)	Preamble error
"	01	"	Frame error
"	02	"	Too few chars
"	03	"	Checksum error
"	08	"	Timeout error (IOL)
"	09	"	Overflow error (IOL)
"	10	"	Checksum error (IOL)
10	00	HARB (")	RC2 Invalid selection
"	01	"	RC3 Passed parameter too large
"	02	"	RC4 Passed parameter too small
"	03	"	RC5 Too few data bytes received
"	04	"	RC6 Device specific command error
"	05	"	RC7 In write protect mode
"	06	"	RC16 Access restricted
"	07	"	RC18 Invalid units code
"	08	"	RC32 Device is busy
"	09	"	RC64 Command not implemented
"	10	"	RCxx Other single definition response code
"	11	"	RCxx Command-specific response code
11	00	SYSA (System)	WD reset
"	01	"	Invalid reset
"	02	"	Stack error
"	03	"	Hard fault

"	07	"	Fuse blow error
"	08	"	AVDD error
"	09	"	IOVDD error
"	10	"	ALDO error
"	11	"	DLDO error
"	12	"	20mV error
"	14	"	V6V error
"	15	"	V24V error
12	00	SYSB (")	WD reset (R)
"	01	"	Invalid reset (R)
"	02	"	Stack error (R)
"	03	"	Hard fault (R)
"	08	"	V24V error (R)
"	09	"	Vana error (R)
"	10	"	Vdig error (R)
"	11	"	I error (R)
"	12	"	Fuse blow error (R)
"	13	"	Vcc error (R,IOL)
"	14	"	Vdd error (R,IOL)